

### Limited Lifetime Warranty

Phoenix Products, Inc. warrants its faucets against defects in material or workmanship, ordinary wear and tear excluded. Special finishes other than chrome are warranted to for (1) year. Should any faucet, part or parts thereof prove defective, contact us for assistance. Repair or replacement will be made without charge upon return of the defective material. **Liability for consequential damages under any and all warranties are excluded to the extent such exclusion is permitted by law.** Some states do not allow exclusion or limitation and exclusion may not apply to you. This warranty gives you specific legal rights, and you may also have other rights which vary from state to state.

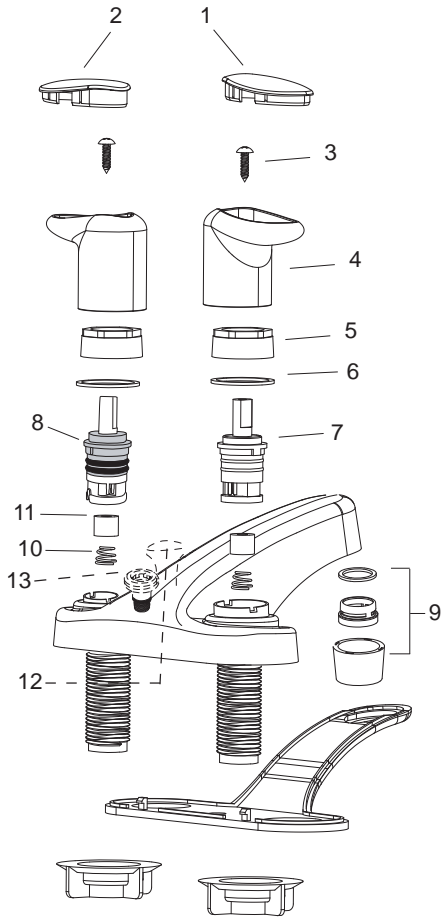

| No. | NAME                                 |
|-----|--------------------------------------|
| 1   | HOT BUTTON (CLEAR)                   |
| 2   | COLD BUTTON (CLEAR)                  |
| 3   | SCREW                                |
| 4   | HANDLE (CLEAR)                       |
| 5   | CARTRIDGE NUT                        |
| 6   | CARTRIDGE NUT WASHER                 |
| 7   | HOT SIDE CARTRIDGE                   |
| 8   | COLD SIDE CARTRIDGE                  |
| 9   | AERATOR (CHROME)                     |
| 10  | SEAT SPRING                          |
| 11  | SEAT WASHER                          |
| 12  | DIVERTER KNOB (DIVERTER MODELS ONLY) |
| 13  | D-SPUD (DIVERTER MODELS ONLY)        |



NOTE: Actual parts for your faucet may not look like those shown here. This illustration is for the purpose of identifying the name and placement of parts. For models with a pop-up drain, separate instructions for pop-up installation are enclosed.

\*Asterisked parts are not standard on all models.

For additional information call us toll free or visit us online at [phoenixfaucets.com](http://phoenixfaucets.com)

Catalina RV Faucets and Parts  
 a division of Phoenix Products, Inc.  
 583 Miller Rd.  
 Avon Lake, OH 44012  
 1.440.933.8100 Phone  
 1.800.222.6041 Toll free  
 1.440.933.6252 Fax  
[www.faucets.com](http://www.faucets.com)

©Phoenix Products, Inc. All rights reserved

## 2 Handle Lavatory Faucets

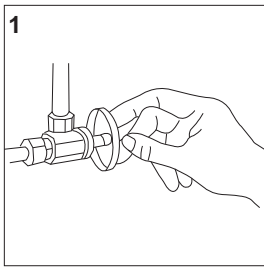

## INSTALLATION:

### 1. SHUT OFF SUPPLY

Shut off hot and cold water supply lines. Clear Sink ledge of all debris.

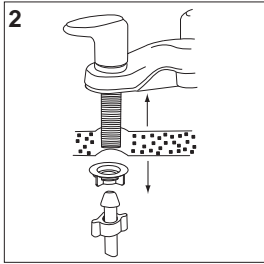

### 2. POSITION FAUCET

Spread a small amount of tub and tile caulk on the surface of the bottom plate facing the counter or sink. Position faucet through bottom plate, down through holes of counter top or sink.

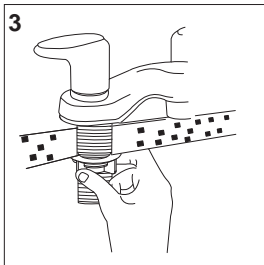

### 3. TIGHTEN NUTS

Align faucet from underside of mounting surface and secure by hand tightening locknuts. **THE BOTTOM PLATE MUST BE USED.**

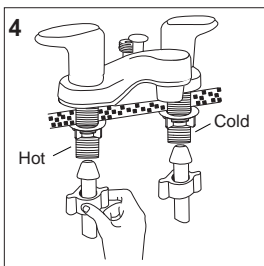

### 4. CONNECT WATER SUPPLY

Connect water supply: Hot water to the left and cold water to the right. Make sure that the end of your existing supply line is straight and will touch the chamfer on the inside of the threaded shank. Screw the tailpiece nut onto the faucet shank. Hand tighten.

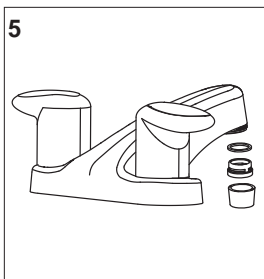

### 5. FLUSH LINES

Remove aerator.

Turn on water supply to faucet. Flush lines by running both cold and hot water through faucet in full open position for 15-20 seconds. Replace aerator (do not cross thread). Check supply lines for leaks. If aerator ever becomes clogged, repeat flushing.

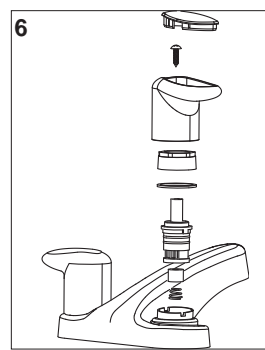

### 6. WASHERLESS CARTRIDGE

If the faucet develops a leak, it may be the result of debris in the water line which is preventing a good seal. Turn the faucet full on and off several times to flush out any material that may be lodged in the faucet. If the problem persists, follow these steps:

Turn off the water supply. Open the faucet to relieve any line pressure. Unsnap the Hot or Cold index button on the handle. Remove the handle screw using a phillips screwdriver. Lift the handle off. Remove the cartridge nut counterclockwise with an 8" crescent wrench. Remove the cartridge by gently prying the cartridge flange up with a small blade screwdriver. Remove rubber seat washer if necessary to remove debris. Replace all

components in reverse order. Make sure triangle arrow on bonnet face points outboard and keys are in keyway. Turn water on and check for leaks. Replace handle, screw and button.

## OPERATING INSTRUCTIONS

Rotating the hot side lever handle counter clockwise, and likewise rotating the cold side lever handle clockwise, opens the cartridge and causes water to flow out the aerator. The degree of handle opening determines the volume of water flow.

Returning the lever handles to their original position stops the water flow.

## DIVERTER MODEL

Pull up on lift rod knob to divert water flow from the aerator to the hand held shower head. To undivert water flow to the hand held shower head, turn off water flow at the faucet handles.

## CAUTIONS:

All plastic connections should be hand tightened. **DO NOT USE TOOLS.**

No sealant of any kind should be used between the tailpiece nut and the faucet shank.

## HELPFUL HINTS

Be especially careful when screwing threaded connections together. Do not tighten any connection if the parts are not threading evenly. Unscrew the parts and start over.

## CLEANING TIPS

The finish on your Phoenix faucet is designed to retain its beautiful sheen for years. To maintain the original look of the finish, we recommend the use of mild soap and water to clean the faucet. **THE USE OF ABRASIVE CLEANERS MAY SCRATCH THE FINISH.**